



Easy Educator EZ-900

Quick Start Guide

E-Collar Technologies, Inc.

Welcome

Thank you for trusting us with your purchase of the 900 Easy Educator Remote Education Collar. We have made every attempt to provide you with the most technologically advanced product using the most stringent quality and manufacturing standards.

We are confident you will be pleased with the results you will attain with the 900 Easy Educator. Please remember you will get better results with the use of low level stimulation combined with consistent training techniques. The use of high levels of stimulation should only be used as a last resort and in life-threatening situations.

Good luck with your training and please feel free to contact us should you have any questions

* This guide will familiarize you with the basic functions, programming features and the contents of the 900 Easy Educator.

Additional information and help is available on www.ecollar.com and e-mail by e-mailing customerservice@ecollar.com. To talk to a live team member please contact our customer service department, 8 AM to 8 PM E.S.T., 1-855-326-5527 or (260) 357-0051. Your total satisfaction is our only concern.

TABLE OF CONTENTS

● Characteristics	3
● Package Contents	4
● Turning ON/OFF the EZ-900 System / Charging Instructions	5
● EZ-900 Functions	6
● LCD Display 1 Dog Mode	7
● Buttons Descriptions and Stimulation Button Assignments	8
● I Mode / Lock and Unlock Stimulation Level	10
● Booster Level Setup / Lost Transmitter Activation	12
● EZ-900 One Dog Default Settings	13
● Expand to Two Dog	14
● Pairing	15
● Warranty and Registration	16

CHARACTERISTICS

- 1/2 mile Range
- Employs Quick Charge Li-Polymer Batteries
- Convenient Intensity Dial for Quick Adjustment
- Stimulation Levels Adjustable from 0 to 100
- Collar Receiver Light for Night Tracking
- “Lock and Set” Stimulation Safety Feature
- User Adjustable Boosting Levels
- Patented “I” Mode Provides Instant Stimulation
- Waterproof and Shock Resistant
- Easily Expandable to 2 Dogs

04

PACKAGE CONTENTS

- Ergonomic Transmitter - Remote-Sender

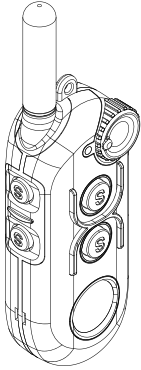

- Waterproof Collar Receiver High Quality Biothane Strap

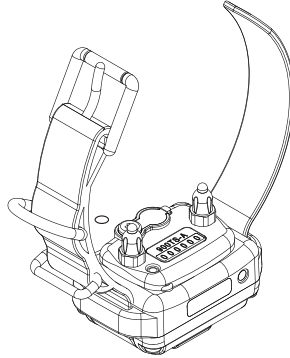

- Quick Start Owner's Guide

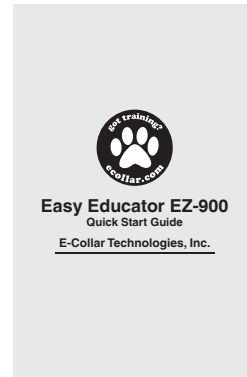

- Test Light

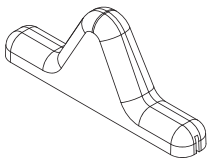

- Contact Point Tool



- 5/8" and 3/4" Contact Points

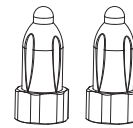

- Lanyard

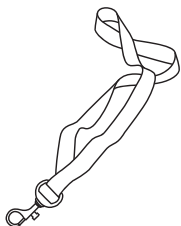

- Battery Charger

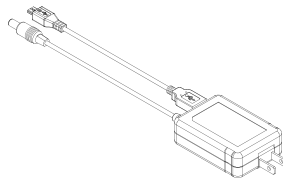

Turning ON/OFF the EZ-900 System

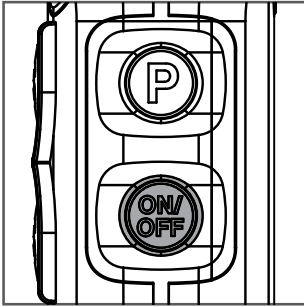

Turn ON/OFF the transmitter by pressing the lower right button for 1 second.

Turn ON/OFF the collar receiver by placing the red dot on the transmitter on the red dot on the collar receiver for 1 second.

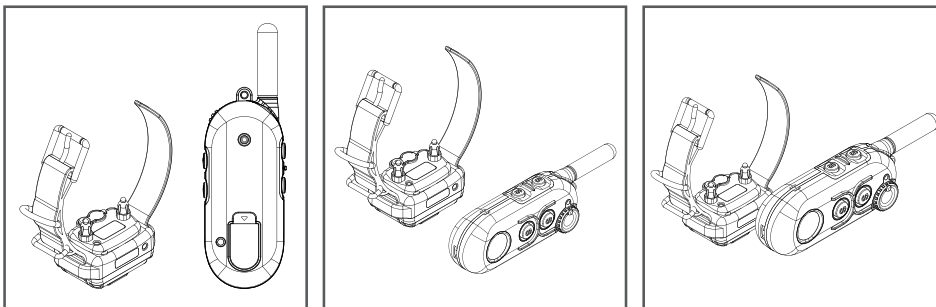

Charging Instructions

Please charge the units on or before the low battery indication. It is best not to wait until the batteries are fully drained to avoid damage. To charge insert the micro USB into the transmitter and the charge plug into the collar receiver as pictured. Store with 50% charge in cool dry place.

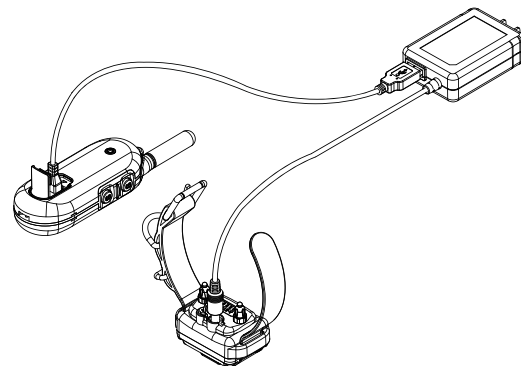

Low Battery Indication

Transmitter: One bar remaining on the LCD display indicates charging is needed.

Collar Receiver: Yellow light indicates low and red indicates very low battery life.

06

EZ-900 Functions

Easy Educator 900 provides 5 types of stimulation sensations, tone, and vibration.

Stimulation		
Icon	Function	Description
M	Momentary Stimulation	Send momentary stimulation (volume level)
M+	Momentary Boost Stimulation	Send momentary boosting stimulation (volume + boost Level)
C	Continuous Stimulation	Send continuous stimulation (max 10 sec, volume level)
C+	Continuous Boost Stimulation	Sends continuous boosting stimulation (max 10 sec, volume + boost level)
I	Instant Mode	Without pressing any button, it will send continuous stimulation by rotating volume dial. (max 45 sec)

Others		
Icon	Function	
V	Vibration	Sends vibration (max 30 sec)
T	Tone	Sends tone (max 30 sec)

LCD DISPLAY

1 DOG Mode

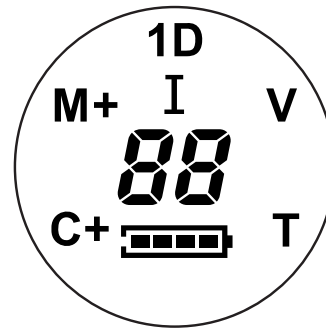

Icon	Description	Remarks
M	Momentary Stimulation	Short Pulse of Stimulation
M+	Momentary Boost Stimulation	Short Pulse of Boosted Stimulation
C	Continuous Stimulation	Up To 10 Seconds of Stimulation
C+	Continuous Boost Stimulation	Up to 10 Seconds of Boosted Stimulation
I	Instant Stimulation Mode	Stimulation Level Displayed on the LCD, Must Start From "0"
V	Vibration	Non Stimulation Sensation Similar to a Vibrating Cell Phone
T	Tone	Audible Tone
Number	Stimulation Level	0 to 100(HI) level

08

Buttons Descriptions and Stimulation Button Assignments

The 900 Easy Educator has 4 control buttons which are assigned to stimulation, vibration and tone. It also has 2 program buttons for changing modes (P) and turning the unit ON and OFF. The convenient dial provides for easy and sight free control of the stimulation level.

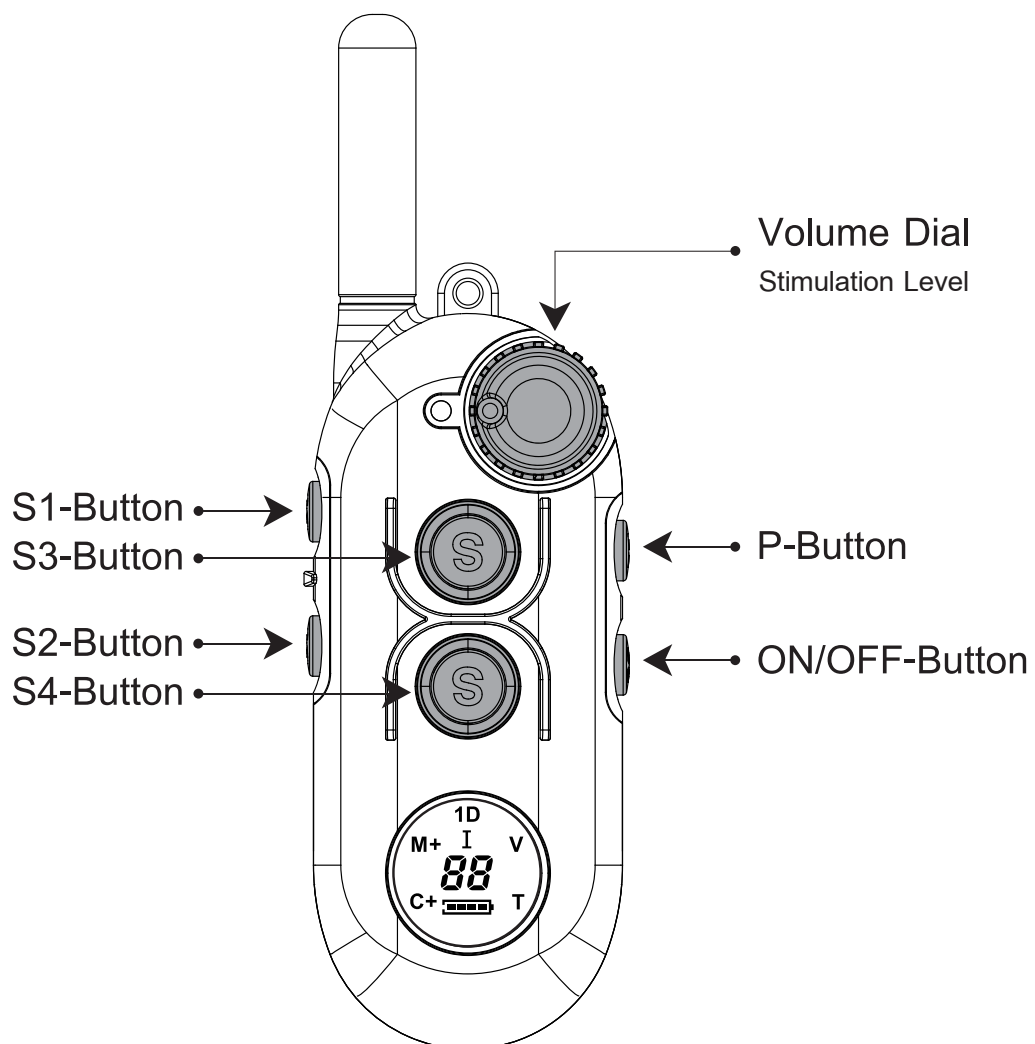

Program Buttons	Function	Description
ON/OFF	Power ON/OFF	Press more than 1 sec to turn ON Press more than 2 sec to turn OFF
	Night Light	Press ON/OFF quickly to activate Light Toggles (Blinking → Solid → OFF)
P	Volume Lock Stimulation Lock Level	Press more than 1 sec to Lock/Unlock Stimulation Level
	Mode Buttons	Set Stimulation to Level "0" S1 mode change: P+S1 (M→C→V→T) S2 mode change: P+S2 (C→V→T→M) S3 mode change: P+S3 (V→T→M→C) S4 mode change: P+S4 (T→M→C→V)

Control Buttons	Function Possibilities
S1-Button	M / C(I) / V / T
S2-Button	M / C(I) / V / T
S3-Button	M / C(I) / V / T
S4-Button	M / C(I) / V / T
LCD Display	M / C / V / T
Booster Function	S1+S2, S2+S1 S3+S4, S4+S3 It is only activated when first button is M or C

- To start Instant mode, rotate volume to level 0 and press a button set to continuous "C" mode activates the "I" mode when pushed on level "0"
- To exit from Instant mode, press any button or wait for the 45 second time out.

10

I Mode / Lock and Unlock Stimulation Level

"I" Instant Stimulation Mode

The "I" mode is a patented feature which allows the stimulation to increase gradually as determined by the user. The gradual introduction of stimulation provides a more gentle sensation and removes the startling effect sometimes associated with applying a constant level of stimulation. The dog produces less cortisol and learns to avoid the higher levels by responding quickly to the command. The user has the flexibility of increasing the stimulation fast if the situation warrants a quick response from the dog.

How Instant Stimulation "I" Mode Works

1. Change the mode of any S button to Continuous if not already programmed to "C" mode : The stimulation dial must be turned to "0" to enter the "I" mode.
2. To start the "I", push the assigned Continuous button. The display will flash On to indicate it is on and ready to begin stimulation.
3. Turning the stimulation will now activate the stimulation at the setting of the dial and continue for 45 seconds.
Returning to "0" will reset the 45 second safety timer.
4. If you do not rotate the dial for 45 seconds the "I" mode will turn off and the control button will need to be pushed again.
5. Pushing any of the other control buttons will turn off the "I" mode and therefore require the "I" mode control be pushed again to reactivate it.
6. Again, to exit the Instant Mode, press any control button or wait for 45 seconds.

Lock and Unlock Stimulation Level

*** Important Note: Blinking "1D" Indicates Unlocked Stimulation /
Solid "1D" Indicates Locked Stimulation**

1. Set the desired stimulation level to be locked by rotating volume dial.
2. Press P (Upper Left) button for more than 1 second.
3. Check LCD display to confirm "1D" icon changes blinking to solid.
4. To unlock, press P button for more than 1 second.

Accessories



Anywear Remote Holder and Quick Receiver shut Off Magnets



Dummy Collars



Hands Free Bungee



Bungee with Quick Connect



Gear Keeper Remote Holder



Bungee Collars and Plus Systems

Many more available on www.ecollar.com

12

Booster Level Setup / Lost Transmitter Activation

Booster Level Setup

1. Change the mode of any S button to Momentary if not already programmed to “M” mode.
2. Change the Stimulation level to “0”
(Stimulation level should be unlocked)
3. Press Momentary button for more than 5 sec and enter into Booster Level Change Mode.
4. Check LCD displays M+ / C+ icon
5. Rotate the dial to change the booster level.
(The range of booster level is from 1 to 60, default is 5)
6. Press Momentary Button again to exit from Booster Level Change Mode.

Lost Transmitter Activation (6 Hour Timer)

1. Change the **Stimulation** level to “0”
2. Press ON/OFF button and then press P button simultaneously.
3. **One short** beep will sound confirming the activation of the locator timer.
4. To deactivate, press ON/OFF button and P button one more time.
5. **Two short** beeps will sound confirming the deactivation of the locator timer.
6. The transmitter will start beeping 6 hours from activation so plan your excursion accordingly.

EZ-900 One Dog Default Settings

Factory default setting of EZ-900 is as below. You can change Tone Mode, Vibration Mode, and Instant Mode by using computer interface tool which can be downloaded at <http://www.ecollar.com>

Factory Default Setting	
S1-Button	Momentary
S2-Button	Continuous
S3-Button	Vibration
S4-Button	Tone
Boost Level	5
Tone Mode	Mode – 2
Vibration Mode	Mode – 4
Instant Mode	Normal Mode

14

Pairing/Syncing

When you change transmitters or collar receivers they will need to be paired/synced to each other for them to communicate with each other.

Pairing/Syncing (ON/OFF + S3)

1. Turn on the Transmitter.
2. Rotate the intensity dial to "0".
3. Turn off the collar receiver. Put the red dot on the transmitter against the red dot on the collar receiver for more than 5 seconds till the solid green light starts blinking on and off rapidly.
4. Press the ON/OFF button and then press the S3 button (Front Top) simultaneously.
5. Listen for confirmation sound from the Collar Receiver.
6. Test the collar receiver to make sure it accepted the new transmitter

15

Expand to Two Dog

(Press On/Off+S3+S4 for 5 sec)

EZ-900 can be easily expanded to two dog EZ-902.

When you purchase additional Collar Receiver, you can change EZ-900 Transmitter to operate like an EZ-902, see website for owner's manual.

1. Rotate the intensity dial to "0".
2. Press the ON/OFF button and then press S3 button (Front Top) & S4 button (Front Bottom) simultaneously for 5 sec.
3. Three short beep sounds will confirm that S/W is changed to EZ-902 Mode successfully. (2D icon will be appeared at LCD Display)
4. If you want to change back to an EZ-900, press ON/OFF button + S1 + S2 for 5 sec.

After expanding to EZ-902, 2nd Collar Receiver should be paired to Transmitter. For the additional information, please refer to EZ-902 manual which is available at <http://www.ecollar.com> .

WARRANTY AND REGISTRATION



To register your Pro Educator please select one of the following procedures

(1) Go to the “Products” section on www.ecollar.com and click the “Register Your e-Collar Products” tab and complete the form

(2) Fill out the provided warranty registration card and mail it or fax it to us at 1-855-226-5527.

(3) Call us at (260) 357-0051 and one of our customer service representatives will register your products for you, please have your serial number available.

Two Year Full Warranty:

Your product is covered by our full two year warranty. During the warranty period we will repair and or replace your product for any reason due to workmanship and component failures. Dog chews and misuse are not covered by the warranty and are subject to a repair/replacement fee.

CONTACT INFORMATION



E-Collar Technologies, Inc.

2120 Forrest Park Drive

Garrett, IN 46738

Toll-Free 1-855-326-5527

Toll-Free Fax 1-855-226-5527

International : 001-260-357-0051

www.ecollar.com

sales@ecollar.com

customerservice@ecollar.com

This product is covered by various patents including but not limited to patents 8757098 and 8833309. Patent is pending on the Instant Stimulation Feature on this device.

Copyright 2014 E-Collar Technologies, Inc. All Rights Reserved.

IMPORTANT NOTICE

About Contact Points:

Many dogs in our modern society have developed sensitivity to nickel which is a metal in all stainless steel products. Keep a watchful eye on your dogs skin where the contact points are touching his/her skin for redness or any signs of irritation. This should be done hourly at first and slowly transition to once every four hours after a month of daily wearing of the e-collar. At first notice of redness immediately switch to one of our hypo allergenic contact points, we offer both nickel free stainless steel and titanium contact points. Dogs with sensitive skin and certain breeds with known skin sensitivities like Pit Bull Terriers and Boxers should be switched early in the process as a precautionary move.



Nickel Free Stainless Steel



Available on www.ecollar.com or by calling 1-855-326-5527



E-Collar Technologies, Inc.

**2120 Forrest Park Drive
Garrett, IN 46738-9471**

1-260-357-0051 (US & International)

1-855-326-5527 (US Toll Free)

1-855-226-5527 (US Toll Free Fax)

sales@ecollar.com

www.ecollar.com

Patents Pending

© 2014 E-Collar Technologies, Inc.



Thank you for Supporting American Workers